ABB MEASUREMENT & ANALYTICS | DATA SHEET

AO2000 System

Analyzer systems for emission monitoring,
cement applications and process measurement



Measurement made easy

Use of the AO2000 analyzer modules

- Uras26 or Limas21 UV photometers
- Magnos206, Magnos28 or Magnos27 oxygen analyzers or electrochemical oxygen sensor
- Fidas24 flame ionization detector

Continuous determination of the concentration of max. six sample components, e. g. CO, NO, SO₂, CO₂, O₂ and VOC

Automatic calibration normally with air and integrated calibration cells, i. e. without use of test gas bottles

Complete analyzer system

- With gas sampling, sample conditioning and gas analyzer
- Inclusive system control and self-monitoring
- In sheet steel or glass-fiber cabinet or on mounting plate
- For installation in non-hazardous area

Options:

- Dual Sampling for simultaneous measurement at two different sampling locations
- Dual Switching for measurement at two sampling locations or for uninterrupted measurement at one sample location for CO monitoring

CSA approval for 'General Purpose' use

Contents

	Page
Description	3
General emission monitoring – Small measuring ranges	5
Cement applications – Kiln outlet or calciner outlet (T > 900 °C)	6
Cement applications – Calciner (T < 900 °C)	7
Cement applications – Wet kiln gas outlet (T < 300 °C)	8
Cement applications – Preheater/CO monitoring of ESP	9
Cement applications – Coal bin, coal mill	10
General purpose process measurement	11
Option 'Test gas infeed at the sampling probe/ upstream of the sample gas cooler'	12
Option 'Dual sampling'	13
Option 'Dual switching'	14
General data	15
Sheet steel cabinet: Exterior view	17
Sheet steel cabinet: Interior view	18
GRP cabinet: Exterior view	19
GRP cabinet: Interior view	20
Mounting plate: View	21
Electrical distribution cabinet: Exterior view	22
Back-purging unit: Exterior and interior view	23

Note

The gas flow plans and arrangement drawings depicted in this data sheet are examples and generally show versions of the analyzer system which are equipped with all options. The system drawings of the analyzer system as-delivered are stored on a CD-ROM which is supplied with analyzer system.

Sales



Service



Description

Applications

Emission monitoring

The AO2000 System is used for the continuous and quantitative detection of gas concentrations for emission measurement. It is equipped with the components which are qualified according to the approval criteria of EN 15267 for use in plants requiring official approval according to Directive 2010/75/EU Chapter III (formerly Directive 2001/80/EG, 13th BIm-SchV) and Chapter IV (formerly Directive 2000/76/EG, 17th BIm-SchV) as well as in plants of 27th/30th BImSchV and of TA Luft (German Technical Instructions on Air Quality). The requirements based on QAL1 according to EN 14181 and EN ISO 14956 are fulfilled. For further information on the analyzers please refer to the 'Advance Optima AO2000 Series Continuous gas analyzers' data sheet.

Cement applications

Another range of application of the AO2000 System is the continuous detection of the gas concentration in cement plants during the primary combustion in rotary kilns and during the secondary combustion at the gas outlet of the calciner. In addition, the AO2000 System is suitable for CO monitoring and emission monitoring tasks in cement plants as well as for process gas monitoring in rotary kilns with wet process.

Process measurement

The AO2000 System can also be used for general purpose process measurement tasks.

System variants

Emission monitoring

- General emission measurement – small measuring ranges

Cement applications

- Kiln outlet or calciner outlet (T > 900 °C)
- Calciner (T < 900 °C)
- Wet kiln gas outlet (T < 300 °C)
- Preheater/CO monitoring of ESP (system T90 time $t_{90} < 10$ sec or $t_{90} = 20-30$ sec)
- Coal bin, coal mill

Process measurement

- General purpose process measurement

System design

The analyzer modules of the AO2000 series used depend on the sample components, measuring ranges and application and enable the selective determination of the proportion by weight (in mg/m³) or the proportion by volume (in ppm or in % vol.) of the sample components in the waste gas, flue gas or process gas.

The effects of ambient temperature, air pressure and associated gas components are compensated for by suitable measures.

The analyzer system is either installed on a mounting plate or in a cabinet of sheet steel or – for use in severe environmental conditions – of glass fiber reinforced plastic.

... Description

Gas sampling

- Probe tube types 40, 40W, 42 or probe 2
- Filter unit PFE2 or PFE3 with optional filter/probe back-purging facility

- Heated or unheated sample gas lines

The analyzer system is also available

- Prepared for integration of sampling probe, filter unit and sample gas line or
- Without sampling probe, filter unit and sample gas line.

Sample conditioning

- Sample gas feed unit SCC-F
- Sample gas cooler SCC-C
- Condensate drainage
- NO₂/NO converter SCC-K

Gas analysis

AO2000 series analyzer modules, installed in a wall-mount housing:

- Uras26 infrared analyzer
- Limas21 UV process photometer
- Magnos206 oxygen analyzer
- Magnos28 oxygen analyzer
- Magnos27 oxygen analyzer
- Electrochemical oxygen sensor
- Fidas24 flame ionization detector

Display and control

Display and control unit and electronics module in the door of the analyzer cabinet or of the separate electrical distribution

Data transmission

Modbus interface for transmission of measured values and status signals as well as analog input, digital input and digital output signals

Calibration

With a few exceptions, no test gases are required for the regular calibration of the analyzer modules.

The analyzer modules Uras26 and Limas21 UV are calibrated at the zero point using ambient air, which must be free of sample components. The air is drawn in by the integrated pump by switching over a solenoid valve and conducted through the sample gas cooler. It is thereby guaranteed that the same gas conditions (humidity) are present during the calibration and during the measurement. The solenoid valve is controlled by the electronics module.

Gas-filled calibration cells are inserted into the optical beam path for the end-point calibration of the analyzer modules. Cleaned ambient air with constant moisture content continues to flow through the sample cell during the calibration.

The calibration cells are tested using test gases from gas cylinders during the recommended annual functional test by the ABB after sales service. These test gases are fed in upstream of the cooler.

The calibration of the oxygen analyzer module Magnos206, Magnos28 and the electrochemical O₂ sensor takes place as single-point calibration with the oxygen concentration of atmospheric air (20.9 % vol.).

If the analyzer module Magnos27 is used for oxygen measurement, a zero reference gas (N₂ gas cylinder with pressure reduction valve) is also required. The automatic calibration of this analyzer module is possible by means of a further solenoid valve.

The analyzer module Fidas24 for the VOC measurement is calibrated using conventional test gases.

Option 'Hydrogen monitoring'

Function

The 'Hydrogen monitoring' option is an additional safety measure when a Fidas24 flame ionization detector is built-in in the analyzer system. If a leak occurs in the hydrogen path inside the analyzer cabinet and hydrogen accumulates inside the cabinet, both the hydrogen supply and the power supply are shut off before the explosion limit is reached – at 40% LEL. This prevents formation of an ignitable mixture.

Scope of supply and delivery

An ATEX-certified gas sensor with connection socket is installed in the analyzer cabinet. A solenoid valve that interrupts the hydrogen supply at 40% LEL and at power supply failure (H₂ safety valve) is installed outside on the right side wall. A gas warning center for evaluating the gas sensor signal, a contactor for disconnecting the power supply to the analyzer cabinet, and a contactor for disconnecting the UPS if the system is prepared for a UPS are also supplied.

Additional options

- Transmission of measured values and status signals via Profibus-DP; as an additional option via Ethernet or via analog and digital outputs
- Remote operation and remote diagnosis as a result of the networkability (Ethernet) of the AO2000 series gas analyzer
- Maintenance on request through self-monitoring
- External signals of components such as dust, volume flow, absolute pressure and temperature can be integrated
- Back-purging: Automatic periodic cleaning of filter units and probe tubes with compressed air
- Dual sampling: Simultaneous measurement at two different sampling locations
- Dual switching: Alternating measurement at two sampling locations or uninterrupted measurement at one sampling location for preheater/CO monitoring of ESP
- Test gas infeed at the sampling probe for calibration according to EPA directives for emission monitoring applications
- Test gas infeed upstream the sample gas cooler
- Sampling system for coal bins and coal mills in the version for use in zone 21 and 22 hazardous areas (on inquiry)

General emission monitoring – Small measuring ranges

Sample components and measuring ranges

	Recommended measuring ranges	Analyzers
CO	0–125 mg/m ³ (max. 625 mg/m ³)	AO2000-Uras26
SO ₂	0–450 mg/m ³ (max. 2250 mg/m ³)	
NO	0–196 mg/m ³ (max. 1000 mg/m ³)	
NO _x	0–300 mg/m ³ (max. 1500 mg/m ³)	with NO ₂ /NO converter
N ₂ O	0–100 mg/m ³ (max. 500 mg/m ³)	
SO ₂	0–75 mg/m ³ (max. 375 mg/m ³)	AO2000-Limas21 UV
NO	0–33.5 mg/m ³ (max. 200 mg/m ³)	
NO ₂	0–250 mg/m ³ (0–1000 mg/m ³)	
O ₂	0–10/25 vol.%	AO2000-Magnos206 /-Magnos28 / O ₂ sensor

Max. 6 sample components are possible.

Gas sampling

Sample gas inlet conditions

Sampling temperature max. 500 °C (932 °F),
 Sampling pressure $p_{abs} = 850\text{--}1100$ hPa (= 0.85–1.1 bar [12.3 to 15.9 psi]),
 Flow rate < 250 l/h (0.15 cfm)
 The sample gas may not be flammable or potentially explosive.

Sampling probes

Sampling temperature < 200 °C (392 °F), low water or acid dew point: Probe tube type 42 (heated), lengths 1000/1500/2000 mm (39.4/59.1/78.7 in).

Sampling temperature > 200 °C (392 °F): Probe tube type 40, stainless steel 1.4571 (AISI 316Ti), lengths 500/1000/1500 mm (19.7/39.4/59.1 in).

Filter unit

Filter unit type PFE2 or PFE3 with regulated heating

Sample gas line

Heated sample gas line type TBL01-S with regulated heating, temperature 200 °C (392 °F), heat output approx. 90 W/m, length dependent on the type of power supply:

Power supply	3-phase	single-phase
230/400 VAC	max. 60 m (200 ft)	max. 35 m (115 ft)
120/208 VAC	max. 40 m (130 ft)	max. 15 m (50 ft)

Gas flow plan

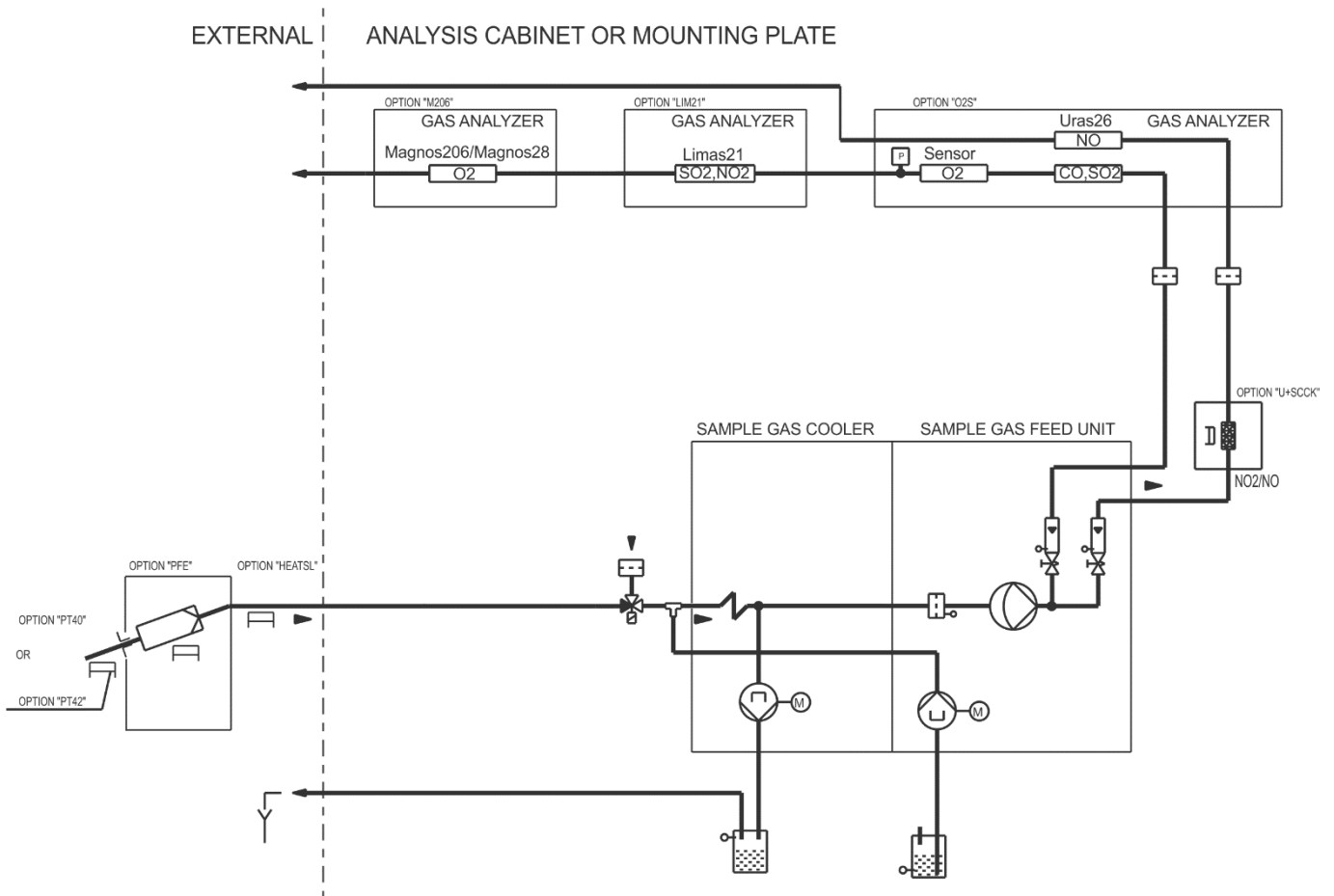

Cement applications – Kiln outlet or calciner outlet ($T > 900\text{ }^{\circ}\text{C}$)

Sample components and measuring ranges

Measuring ranges	Analyzers
CO 0–0.5/3 vol.%	AO2000-Uras26
NO 0–2000/5000 ppm	
NO _x 0–2000/5000 ppm	with NO ₂ /NO converter
CO ₂ 0–40 vol.%	
CH ₄ 0–1000/5000 ppm	
SO ₂ 0–5000/10000/20000/ 40000 ppm	AO2000-Limas21 UV with quartz cell
O ₂ 0–10/25 vol.%	AO2000-Magnos27 or O ₂ sensor

Gas sampling

ABB is offering the sampling system SCK for gas sampling at the kiln outlet or calciner outlet. Please refer to the SCK data sheet for information about sample gas inlet conditions and selection of the sampling probe.

Sample gas line

Ambient temperature $> 0\text{ }^{\circ}\text{C}$ ($32\text{ }^{\circ}\text{F}$) without sample components SO₂ and NO: Unheated sample gas line (PTFE), recommended length max. 20 m (65 ft).

Ambient temperature $> 0\text{ }^{\circ}\text{C}$ ($32\text{ }^{\circ}\text{F}$) with sample components SO₂ and NO or ambient temperature $< 0\text{ }^{\circ}\text{C}$ ($32\text{ }^{\circ}\text{F}$): Heated sample gas line type TBL01-S, self-regulating, temperature $100\text{ }^{\circ}\text{C}$ ($212\text{ }^{\circ}\text{F}$), recommended length max. 20 m (65 ft).

Gas flow plan

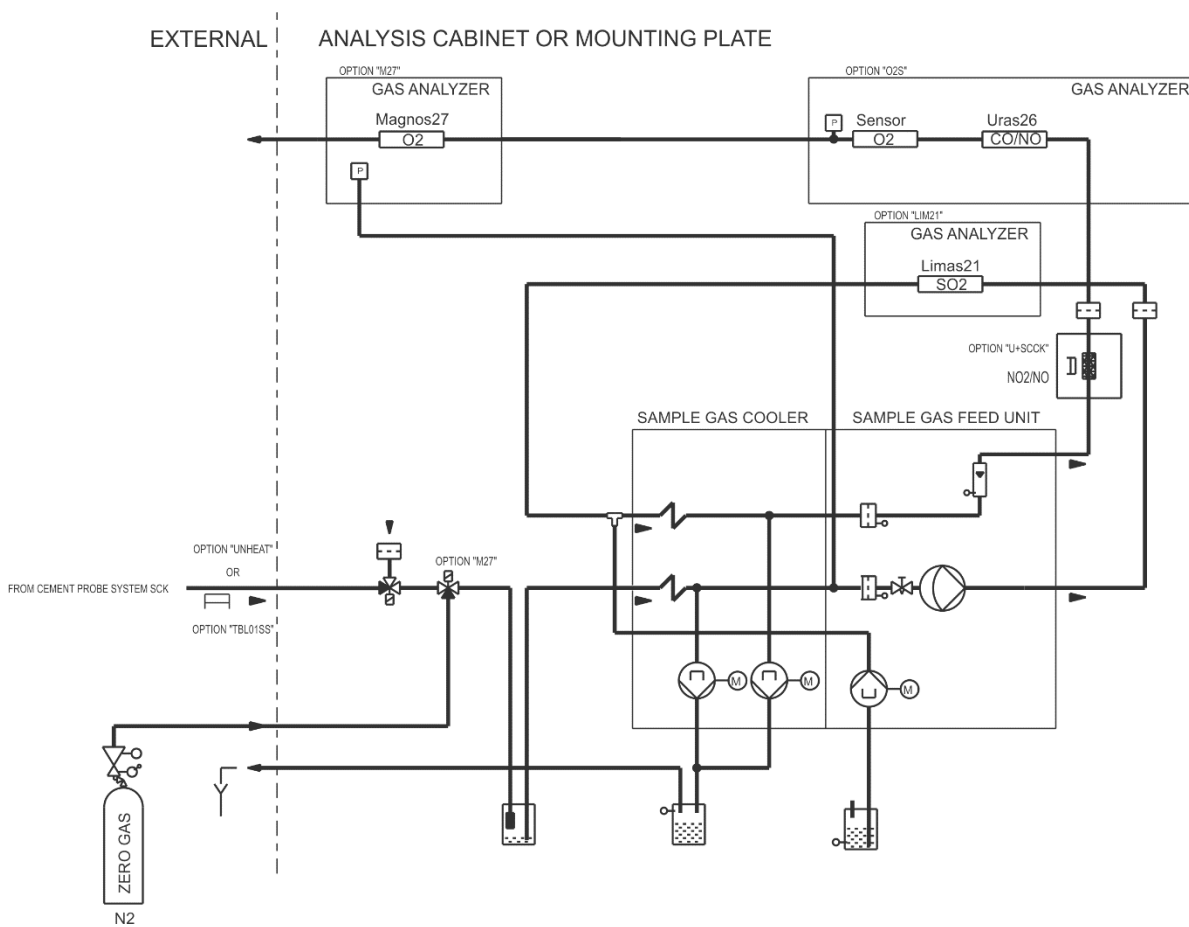

Cement applications – Calciner (T < 900 °C)

Sample components and measuring ranges

Measuring ranges	Analyzers
CO 0–0.5/3 vol.%	AO2000-Uras26
NO 0–2000/5000 ppm	
NOx 0–2000/5000 ppm	with NO ₂ /NO converter
CO ₂ 0–40 vol.%	
CH ₄ 0–1000/5000 ppm	
SO ₂ 0–5000/10000/20000/40000 ppm	AO2000-Limas21 UV with quartz cell
O ₂ 0–10/25 vol.%	AO2000-Magnos27 or O ₂ sensor

Gas sampling

Sample gas inlet conditions

Sampling temperature max. 900 °C (1652 °F),
 Sampling pressure $p_{abs} = 850\text{--}1100$ hPa (= 0.85–1.1 bar [12.3 to 15.9 psi]),
 Flow rate < 125 l/h (0.075 cfm)
 The sample gas may not be flammable or potentially explosive.

Sampling probe

Probe tube type 40, stainless steel 1.4893, lengths 500/1000 mm (19.7/39.4 in)

Filter unit

Filter unit type PFE3 with regulated heating

Back-purging (two-stage)

Option with high visible emission concentration in the sample gas (> 3 g/m³)
 For information on compressed-air supply see page 16

Sample gas line

Ambient temperature > 0 °C (32 °F) without sample components SO₂ and NO: Unheated sample gas line (PTFE), recommended length max. 20 m (65 ft).
 Ambient temperature > 0 °C (32 °F) with sample components SO₂ and NO or ambient temperature < 0 °C (32 °F): Heated sample gas line type TBL01-C, self-regulating, temperature 100 °C (212 °F), recommended length max. 20 m (65 ft).

Gas flow plan

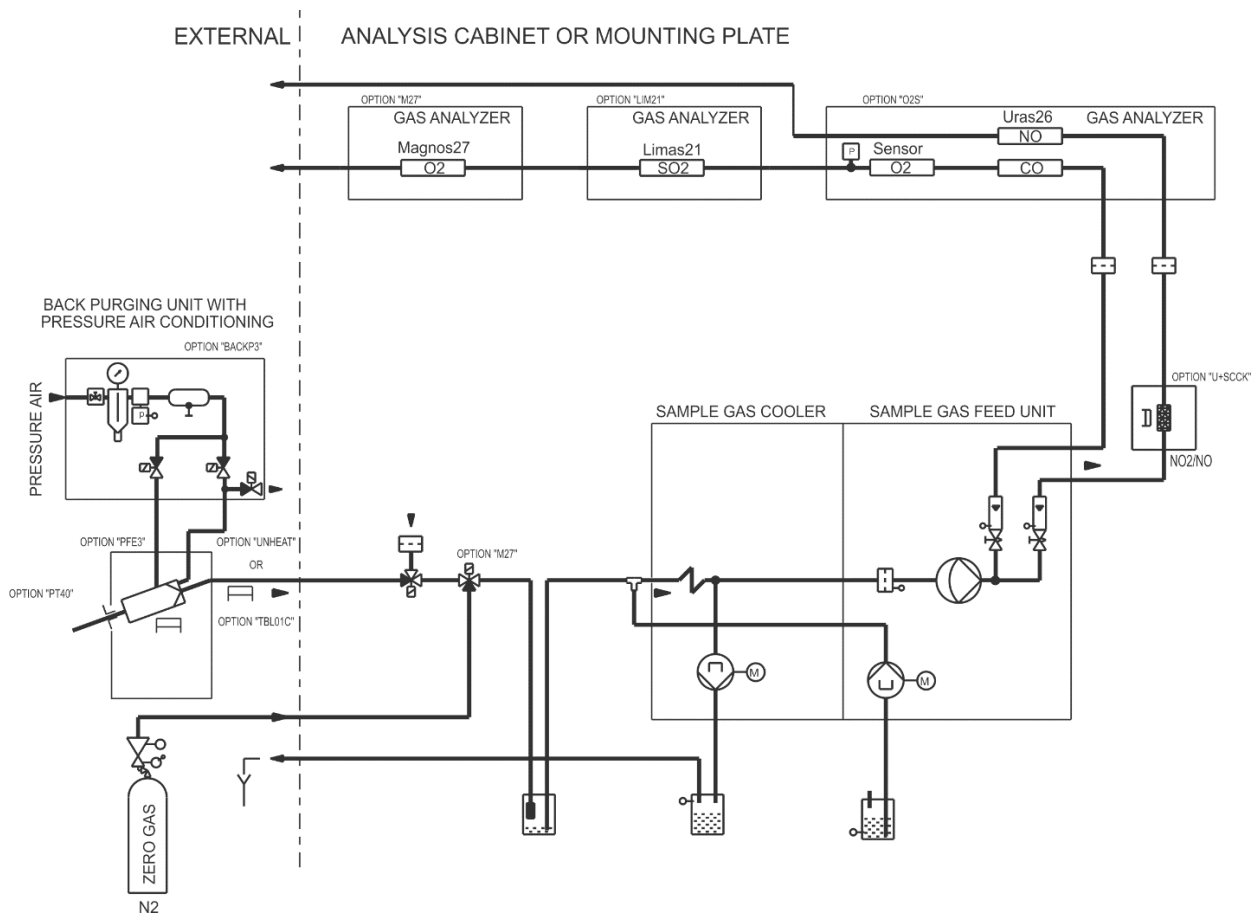

Cement applications – Wet kiln gas outlet (T < 300 °C)

Sample components and measuring ranges

Measuring ranges	Analyzers
CO 0–0.5/3 vol.%	AO2000-Uras26
SO ₂ 0–500 ppm	
NO 0–2000/5000 ppm	
CO ₂ 0–40 vol.%	
SO ₂ 0–5000/10000/20000/ 40000 ppm	AO2000-Limas21 UV with quartz cell
O ₂ 0–10/25 vol.%	AO2000-Magnos27 or O ₂ sensor

Gas sampling

Sample gas inlet conditions

Sampling temperature max. 300 °C (572 °F),
Sampling pressure $p_{abs} = 850\text{--}1100$ hPa (= 0.85–1.1 bar [12.3 to 15.9 psi]),
Flow rate < 250 l/h (0.15 cfm) without or 60 l/h (0.035 cfm) with SO₂ measurement
The sample gas may not be flammable or potentially explosive.

Sampling probe

Probe tube type 40W, stainless steel 1.4571 (AISI 316Ti), with un-regulated partial heating, lengths 3500/4000/4500 mm (137.8/157.5/177.2 in), installation vertically in the smoke chamber

Filter unit

Filter unit type PFE3 with regulated heating

Back-purging (two-stage)

Option with high visible emission concentration in the sample gas (> 3 g/m³)

For information on compressed-air supply see page 16

Sample gas line

Ambient temperature > 0 °C (32 °F) without sample components SO₂ and NO: Unheated sample gas line (PTFE), recommended length max. 10 m (33 ft).

Ambient temperature > 0 °C (32 °F) with sample components SO₂ and NO or ambient temperature < 0 °C (32 °F): Heated sample gas line type TBL01-C, self-regulating, temperature 100 °C (212 °F), recommended length max. 10 m (33 ft).

Gas flow plan

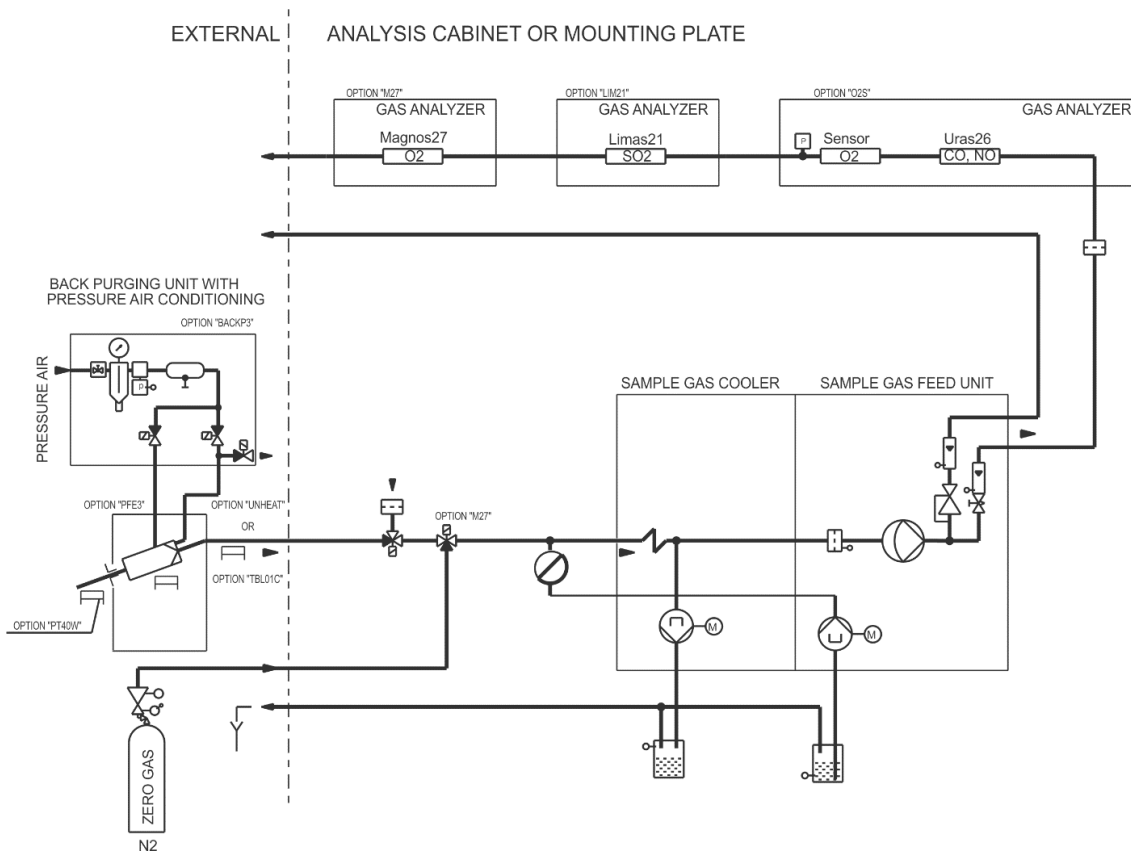

Cement applications – Preheater/CO monitoring of ESP

Sample components and measuring ranges

Measuring ranges	Analyzers
CO 0–0.5/3 vol.%	AO2000-Uras26
NO 0–2000 ppm	
SO ₂ 0–500 ppm	
O ₂ 0–10/25 vol.%	AO2000-Magnos27 or O ₂ sensor

System version ‘AO2000 System fast’

The system version ‘AO2000 System fast’ is intended for fast measurement at preheater/CO monitoring of ESP. By use of the probe F and a max. 10 m (33 ft) long sample gas line as well as special versions of the sample gas cooler and the sample gas feed unit, a system T90 time of $t_{90} \leq 10$ s can be achieved for the sample component CO. This system version is offered for other applications on request.

Gas sampling

Sample gas inlet conditions

Sampling temperature max. 450 °C (842 °F),
 Sampling pressure $p_{abs} = 850\text{--}1100$ hPa (= 0.85–1.1 bar [12.3 to 15.9 psi]),
 Flow rate < 250 l/h (0.15 cfm), < 300 l/h (0.18 cfm) for ‘AO2000 System fast’ fast
 The sample gas may not be flammable or potentially explosive.

Sampling probe

Probe 2 or probe F partially heated, length 1200 mm (47.2 in), without or with one-stage purging facility and compressed-air conditioning.

Probe tube type 40, stainless steel 1.4571 (AISI 316Ti), lengths 500/1000/1500 mm (19.7/39.4/59.1 in), filter unit type PFE3 with regulated heating, without or with two-stage purging facility. For information on compressed-air supply see page 16

Sample gas line

Ambient temperature > 0 °C (32 °F) without sample components SO₂ and NO: Unheated sample gas line (PTFE), length max. 10 m (33 ft).

Ambient temperature > 0 °C (32 °F) with sample components SO₂ and NO or ambient temperature < 0 °C (32 °F): Heated sample gas line type TBL01-C, self-regulating, temperature 120 °C (248 °F), length max. 10 m (33 ft).

Gas flow plan

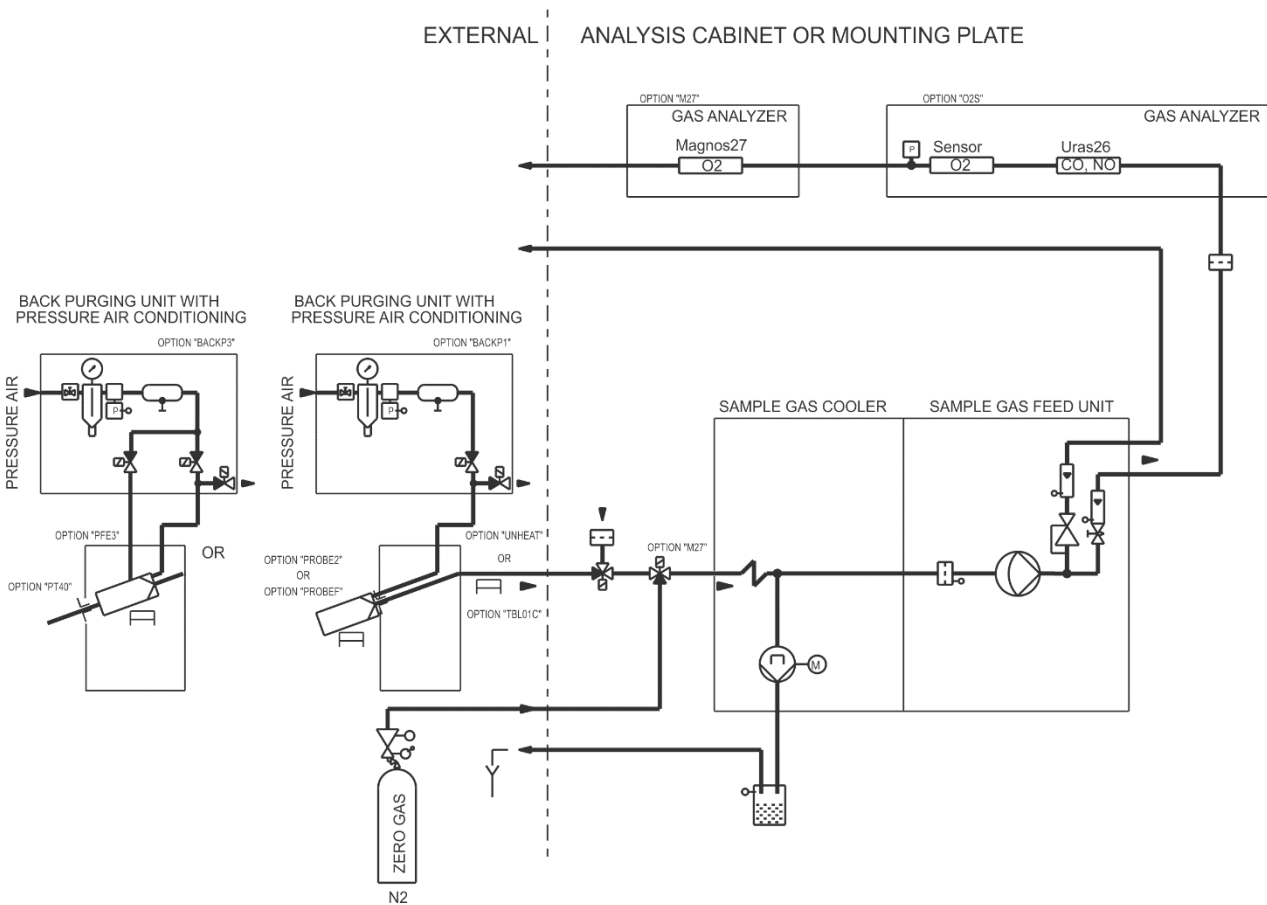

Cement applications – Coal bin, coal mill

Sample components and measuring ranges

Measuring ranges	Analyzers
CO 0–5000/10000 ppm	AO2000-Uras26
O ₂ 0–10/25 vol.%	AO2000-Magnos27 or O ₂ sensor

Gas sampling

Sample gas inlet conditions

Sampling temperature max. 500 °C (932 °F),
 Sampling pressure $p_{abs} = 850\text{--}1100$ hPa (= 0.85–1.1 bar [12.3 to 15.9 psi]),
 Flow rate < 250 l/h (0.15 cfm)
 The sample gas may not be flammable or potentially explosive.

Sampling probe

Probe tube type 40, stainless steel 1.4571 (AISI 316Ti), lengths 500/1000/1500 mm (19.7/39.4/59.1 in)

Filter unit

Filter unit type PFE3 with regulated heating

Back-purging (two-stage)

With compressed-air conditioning; for information on compressed-air supply see page 16

Sample gas line

Ambient temperature > 0 °C (32 °F): Unheated sample gas line (PTFE), recommended length max. 20 m (65 ft).
 Ambient temperature < 0 °C (32 °F): Heated sample gas line type TBL01-C, self-regulating, temperature 100 °C (212 °F), recommended length max. 20 m (65 ft).

Gas flow plan

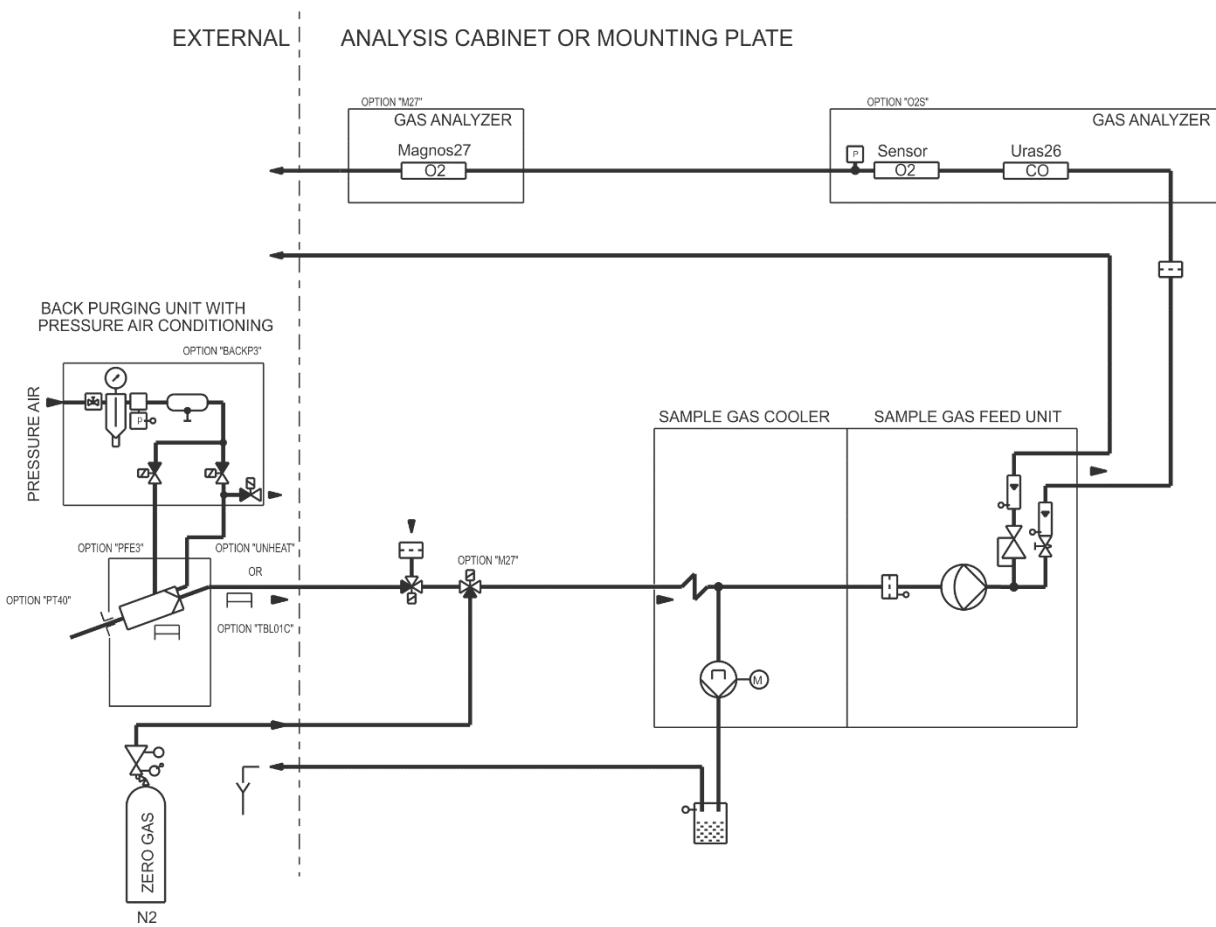

General purpose process measurement

Sample components and analyzers

Sample components and analyzers
CO, SO ₂ , NO, NO _x (with NO ₂ /NO converter), CO ₂ , N ₂ O, CH ₄ : AO2000-Uras26
SO ₂ , NO ₂ , NO: AO2000-Limas21 UV
O ₂ : AO2000-Magnos206, AO2000-Magnos28, AO2000-Magnos27 or O ₂ sensor
VOC: AO2000-Fidas24

The analyzer modules are built-in into a wall-mount housing.

Important note: The completed measuring point data sheet for the desired application is a pre-requisite for an offer/order to be examined and processed fully.

Gas sampling

Sample gas inlet conditions

Sampling temperature max. 500 °C (932 °F),
 Sampling pressure $p_{abs} = 850\text{--}1100$ hPa (= 0.85–1.1 bar [12.3 to 15.9 psi]),
 Flow rate < 250 l/h (0.15 cfm)
 The sample gas may not be flammable or potentially explosive.

Sampling probes

Sampling temperature < 200 °C (392 °F), low water or acid dew point: Probe tube type 42 (heated), lengths 1000/1500/2000 mm (39.4/59.1/78.7 in)
 Sampling temperature > 200 °C (392 °F): Probe tube type 40, stainless steel 1.4571 (AISI 316Ti), lengths 500/1000/1500 mm (19.7/39.4/59.1 in)

Filter unit

Filter unit type PFE2 or PFE3 with unregulated or regulated heating

Back-purging (two-stage)

Option with high visible emission concentration in the sample gas (> 3 g/m³)
 For information on compressed-air supply see page 16

Sample gas line

Heated sample gas line type TBL01-S with regulated heating, temperature 200 °C (392 °F), heating power approx. 90 W/m, length dependent on the type of power supply:
 Power supply 3-phase single-phase
 230/400 V AC max. 60 m (200 ft) max. 35 m (115 ft)
 115/200 V AC max. 40 m (130 ft) max. 15 m (50 ft)
 Heated sample gas line type TBL01-S with self-regulating heating, temperature 100 °C (212 °F), heating power approx. 30 W/m, length max. 60 m (200 ft).
 Unheated sample gas line (PTFE), length max. 25 m (82 ft).

Gas flow plan

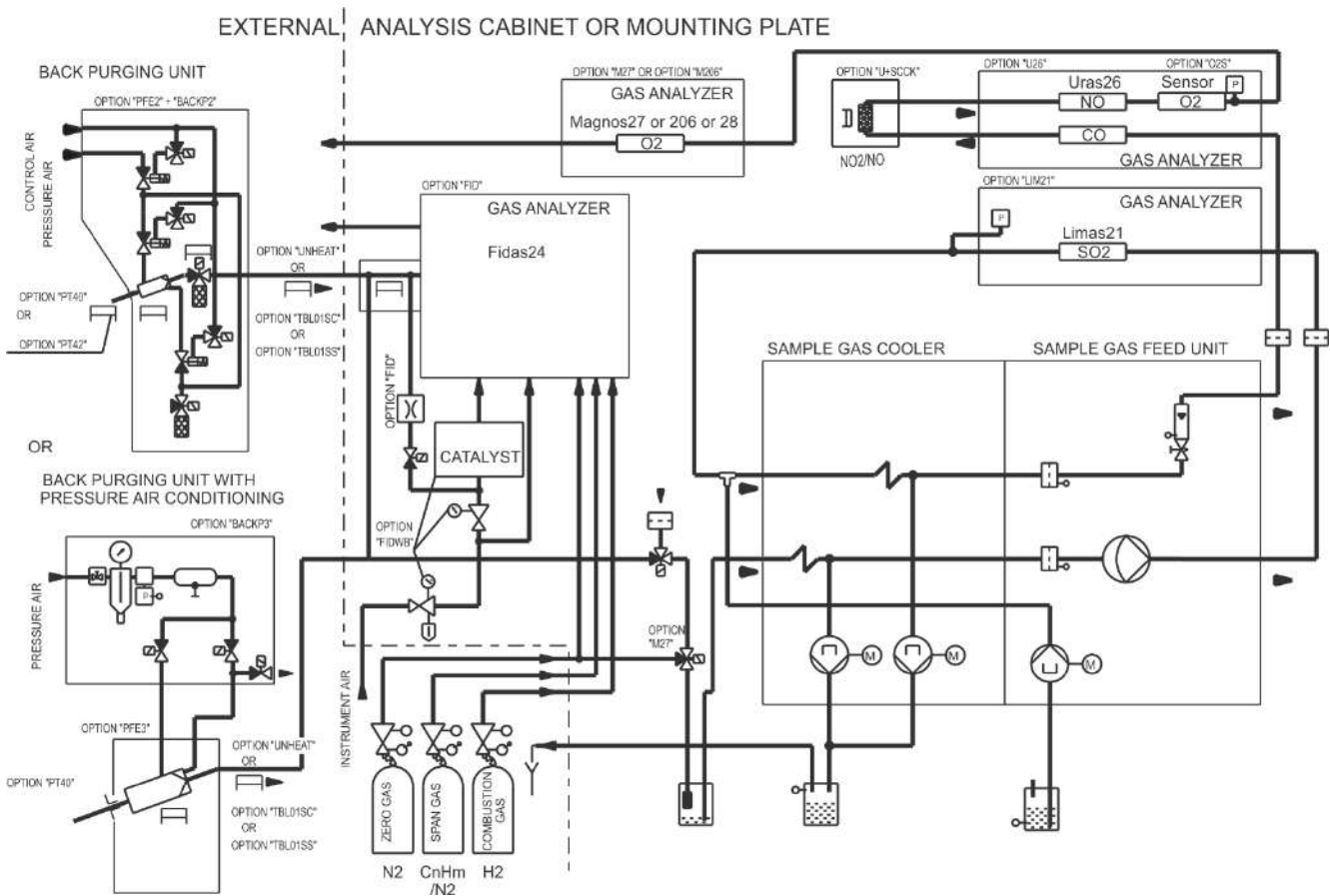

Option ‘Test gas infeed at the sampling probe/upstream of the sample gas cooler’

Test gas infeed at the sampling probe

In the version for emission monitoring pursuant to the directives of the US American Environmental Protection Agency EPA, the analyzer system is calibrated or validated by feeding in the test gases at the sampling probe (option). The requisite solenoid valves are installed in the analyzer cabinet and on the mounting plate.

Automatic calibration or validation is either cyclically time-controlled or started manually on the display and operator control unit of the analyzer system. The cycle times are pre-set ex works; they can be customized to local requirements. The solenoid valves can also be individually activated on the display and operator control unit.

A maximum of three test gas cylinders can be connected. A constant test gas flow is ensured by means of a flow controller and a needle valve.

Calibration or validation for inspection purposes can also be performed without using test gas provided that all the analyzers in the analyzer system have been equipped with calibration cells or specified for single-point calibration.

Test gas infeed upstream of the sample gas cooler

The option ‘Test gas infeed upstream of the sample gas cooler’ can be used for emission monitoring if test gases and sample gas are required at the inlet of the analyzer system under identical conditions.

The prerequisite is that the analyzers have not been equipped with calibration cells and are not specified for single-point calibration.

Gas flow plans

Test gas infeed at the sampling probe

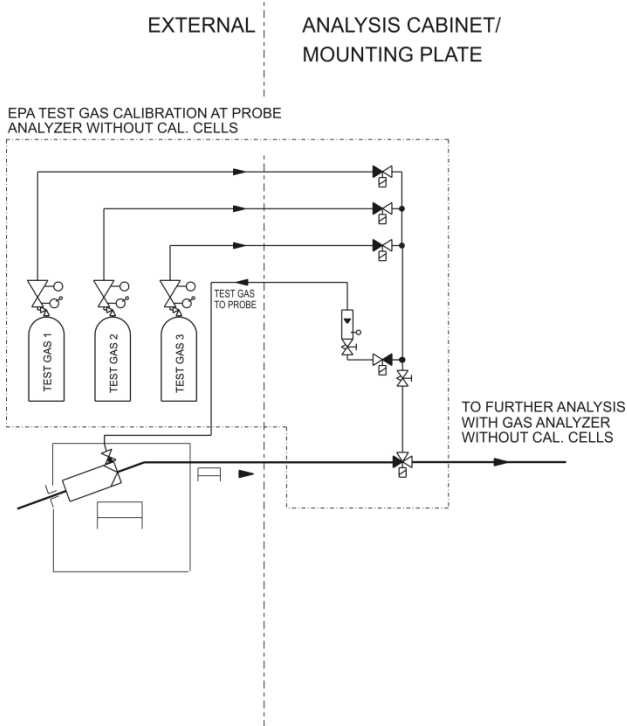

Test gas infeed upstream of the sample gas cooler

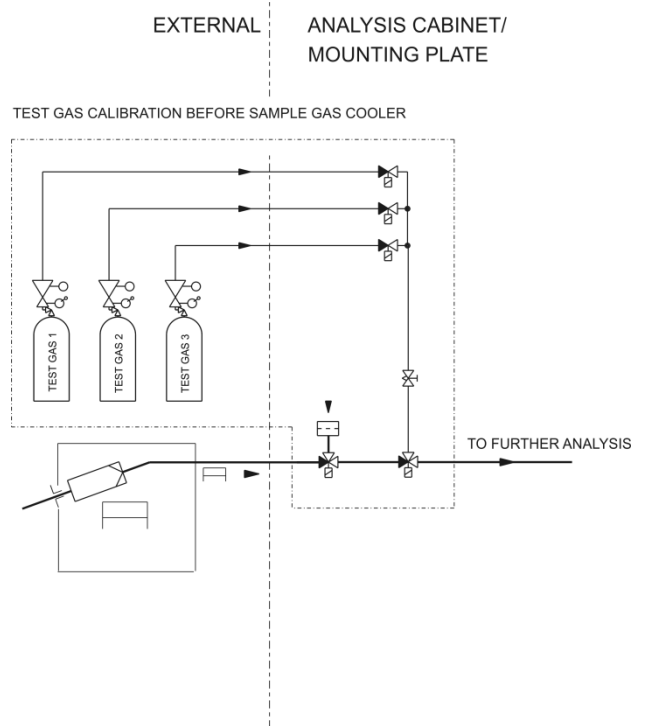

Option 'Dual sampling'

Description

Simultaneous measurement at two different sampling points is possible with the dual sampling option.

Two sample gas feed paths run in parallel from the gas sampling to the gas analysis. Two sampling probes with a filter unit and two sample gas lines are used. In the analyzer system, the modules for conditioning the sample gas and the gas analyzers are equipped with two separate gas feed paths in each case. Only the sample components CO and NO with or without O₂ can be measured in each case.

Back-purging

The automatic filter/probe back-purging (option) is normally executed with two separate back-purging units. If a shared back-purging unit is used for two sampling points, these may not be more than 6 m (20 ft) away from the installation site of the back-purging unit.

The back-purging is carried out simultaneously in both sampling systems. The measuring operation is interrupted during back-purging and calibration.

Gas flow plan

Dual sampling with two separate 2-stage back-purging units

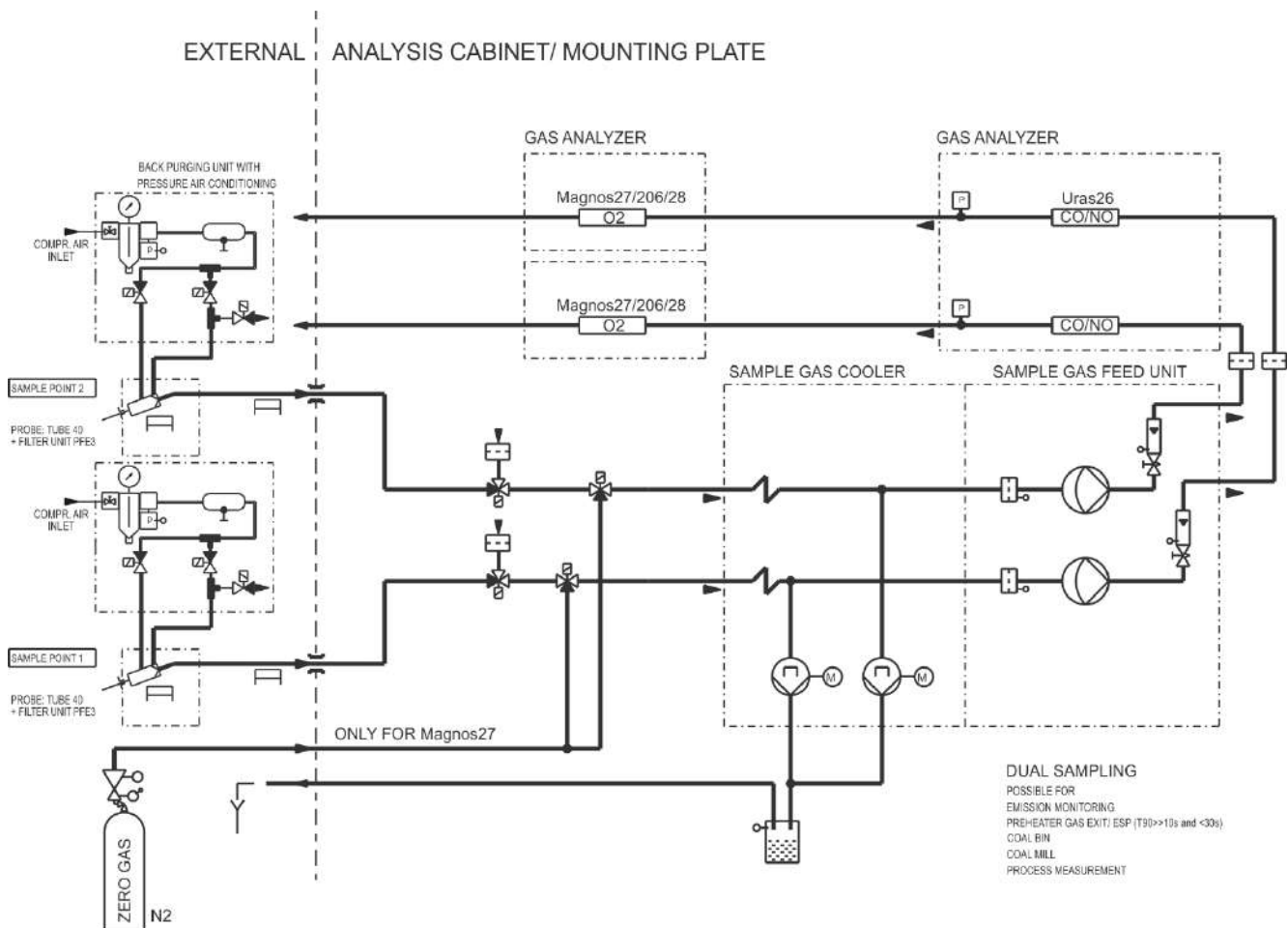

System variants

- Emission monitoring, general
Test gas infeed at the sampling probe and upstream of the sample gas cooler not possible; not with filter unit PFE2 and probe tube type 42
- Preheater/CO monitoring of ESP (t₉₀ = 20–30 s)
Filter unit PFE3 and probe tube type 40 only with automatic two-stage back-purging
- Coal bin, coal mill
- Process measurements, general
(not with analyzer module Fidas24)

Option 'Dual switching'

Description

Alternating measurement at two sampling locations is possible with the dual switching option.

Measurement at two different sampling points

Measurement is only performed at the sampling point connected to the gas analyzer. The inactive sample gas feed path is operated in the pre-sampling mode by means of a separate pump, so that the sample gas is immediately available at the gas analyzer after switchover. Probe cleaning by means of the periodic filter/probe back-purging (option) is only carried out in the inactive sample gas feed path. The measuring operation is interrupted during calibration.

Measurement at the same sampling point

For the CO monitoring of electrostatic filters with a high visible emission load, a sampling location can be equipped with two sampling probes. Uninterrupted measurement is guaranteed by switching between the two probes, also if one of the probes is being cleaned by means of the periodic filter/probe back-purging (option). The measuring operation is only interrupted during calibration.

Gas flow plans

Two different sampling points each with 2-stage back-purging unit

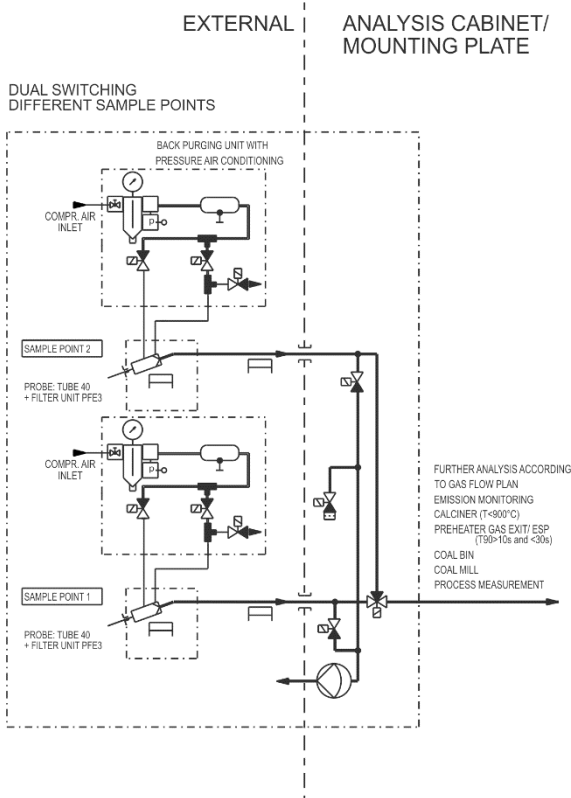

System variants

- Emission monitoring, general
Test gas infeed at the sampling probe and upstream of the sample gas cooler not possible; not with filter unit PFE2 and probe tube type 42
- Calciner (T < 900 °C)
Only with automatic back-purging
- Preheater/CO monitoring of ESP (t₉₀ = 20–30 s)
Filter unit PFE3 and probe tube type 40 only with automatic two-stage back-purging
- Preheater/CO monitoring of ESP ('AO2000 System fast', t₉₀ < 10 s)
Only for measurement at the same sampling point; only with automatic one-stage back-purging
- Coal bin, coal mill
- Process measurements, general
(not with analyzer module Fidas24)

One sampling point with 2-stage back-purging unit

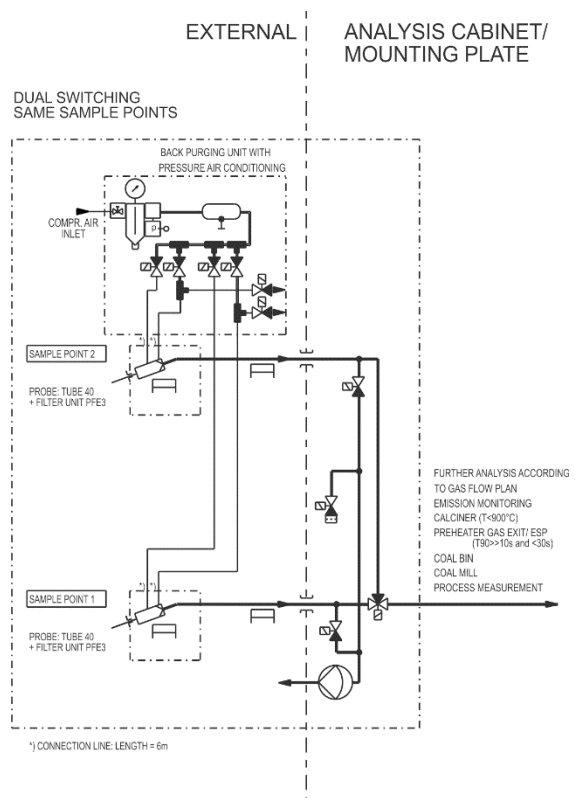

General data

Analyzer system in the cabinet

Design

Cabinet of sheet steel or glass fiber reinforced plastic (GRP), front door (hinged on the left) with integrated display and operator control unit, GRP cabinet with protective window in front of display and operator control unit, mounting plate on the rear panel of the cabinet, electrical distribution cabinet (option) mounted on the left, cooling unit (option) mounted on the right

Color

Light gray (RAL 7035)

Degree of protection

IP54 to EN 60529

Dimensions (W×H×D)

See dimensional drawings on pages 17 and 19

Design of sheet steel: 800×2100×600 mm (31.5×82.7×23.6 in)

Design of GRP: 840×2100×600 mm (33.1×82.7×23.6 in)

Design of GRP with Uras26, Magnos206, Magnos28, Magnos27,

Limas21 UV: 900×2140×700 mm (35.4×84.3×27.6 in)

with cooling unit: in each case W + 250 mm (9.8 in), with electrical distribution cabinet: in each case W + 300 mm (11.8 in)

Weight

Design of sheet steel: max. 430 kg (948 lb)

Design of GRP: max. 370 kg (816 lb)

Analyzer system on mounting plate

Design

Sheet steel, galvanized; electrical distribution in separate sheet steel cabinet with integrated display and operator control unit

Degree of protection

Mounting plate: IP20, Electrical distribution: IP54 to EN 60529

Dimensions (W×H×D)

See dimensional drawings on pages 21 and 22

Mounting plate: 700×1900×350 mm (27.6×74.8×13.8 in)

Electrical distribution cabinet: 580×1400×300 mm (22.8×55.1×11.8 in)

Distance between mounting plate and electrical distribution cabinet: max. 100 mm (4 in)

Weight

Mounting plate: max. 170 kg (375 lb)

Electrical distribution cabinet: max. 65 kg (143 lb)

Measuring signals and status signals

Measuring signals

1 output signal for each sample component

Status signals

Digital outputs for 'Failure', 'Maintenance request' and 'Maintenance mode' (maintenance/calibration). The status signals are generated during the automatic self-monitoring, if applicable, coupled with a safety shut-down of the sample gas pump. Each status message is shown in the display in plain language, entered in the logbook and assigned to one of the three status signals.

Interfaces

Modbus (standard)

Transmission of measured values and status signals as well as analog input, digital input and digital output signals to host systems, e.g. standard Windows applications via M-DDE server; Modbus slave protocol in the RTU (Remote Terminal Unit) mode via the RS485 interface

Profibus (option)

Integration of the analyzer system in Profibus networks for the transmission of measured values and status signals as well as analog input, digital input and digital output signals via the RS485 interface (not in conjunction with Modbus interface)

Ethernet (option)

Data transmission (via router) or remote operation, TCP/IP protocol

Current outputs, digital outputs and inputs (option)

Analog outputs: 0/4–20 mA, max. working resistance 400 Ω

Digital outputs: Floating contacts, max. 250 V AC, 1.5 A, 500 VA

Digital inputs: Floating contacts, 24 VDC supply from the system

Electrical connections

Connections

On terminal strip

Power supply: max. 10 mm² (AWG 6)

Signal lines, power supply of the heated sampling modules: max. 2.5 mm² (AWG 10)

Gas connections

Gas connection of sample gas line

Screw connection for hose 4/6 x 1 mm, unheated;

Conduit for heated line Ø 48 mm

Gas connections for version with AO2000-Fidas24

Heated sample gas line: Flange for heated sample gas inlet of the Fidas24

Combustion gas (hydrogen): Bulkhead fitting for stainless steel tube 4/6 x 1 mm

Instrument air: Bulkhead fitting for stainless steel tube

8/6 x 1 mm or compressed-air hose

Test gases, sample gas outlet, condensate venting: Bulkhead fitting for hose 4/6 x 1 mm

Waste gas outlet Fidas24: Bulkhead fitting for stainless steel tube, 12 mm

Gas supply requirements see page 16

Sample gas filtering

Filter unit

Filter unit type PFE2 or PFE3 with regulated or unregulated heating in a stainless steel protective box, filter fineness 0.3 µm, flange DN 65, PN 6, facing type A to DIN EN 1092-1, positioning of holes: 45°, 90°, 135°, 180°, 225°, 270°, 315°, 360°

... General data

Sample gas feed-in and conditioning

Sample gas cooler

Type SCC-C with glass heat exchanger, automatic condensate drainage and monitoring, safety shutdown of the sample gas pump in the case of condensate breakthrough; condensate collecting bottle with level monitoring

Sample gas feed unit

Type SCC-F with diaphragm pump, condensate monitor and flow monitor with needle valve

Power supply

Operating voltage

230/400 VAC or 120/208 VAC, $\pm 10\%$, 48–62 Hz

Power consumption

Basic version	1000 VA
Cooling unit	940 VA
Analyzer module Fidas24	285 VA
NO ₂ /NO converter SCC-K	350 VA
Heated sampling filter PFE2, PFE3	250 VA
Probe 2, partially heated	225 VA
Heated probe tube type 42	800 VA
Heated sample gas line TBL01 regulated 180 °C (356 °F)	90 VA/m
self-regulating 100 °C (212 °F)	35 VA/m
self-regulating 30 °C (86 °F)	15 VA/m

Prepared for uninterruptible power supply (UPS)

400 VA

Compressed-air supply for filter/probe back-purging

Automatic one-stage or two-stage back-purging facility

Requirements of the compressed-air supply: dry (dew point < 3 °C [37.4 °F]), oil and dust-free; max. 6 bar (87 psi) for back-purging; required air flow rate approx. 100 Nm³/h (59 cfm). See dimensional drawing on page 23

Compressed-air conditioning (option, not for AO2000-Fidas24)

Sheet-steel protective cabinet with shut-off valve, pressure reduction valve 6 bar (87 psi), solenoid valves for back-purging, pressure regulator and 5 l compressed-air tank for effective pressure pulses also with lower air flow rate

Supply gases and test gases for AO2000-Fidas24

Instrument air

Quality in accordance with ISO 8573-1 Class 2 (particle size max. 1 µm, number density max. 1 mg/m³, oil content max. 0.1 mg/m³, pressure dew point at least 10 °C [18 °F] below the lowest expected ambient temperature), Inlet pressure $p_e = 4000 \pm 500$ hPa (58 ± 7.25 psi), Typical flow approx. 1800 l/h (1200 l/h for integrated air jet injector and approx. 600 l/h for case purging [1.06 cfm = 0.71 cfm + 0.35 cfm]), maximum flow approx. 2200 l/h (1500 l/h + 700 l/h [1.29 cfm = 0.88 cfm + 0.41 cfm])

Combustion air

Synthetic air or catalytically cleaned air with an org. C content of < 1 % of the span
Inlet pressure $p_e = 1200 \pm 100$ hPa (17.4 ± 1.45 psi), flow < 40 l/h (0.024 cfm)

Combustion gas

Hydrogen (H₂), Quality 5.0. Inlet pressure $p_e = 1200 \pm 100$ hPa (17.4 ± 1.45 psi), flow ≤ 3 l/h (0.106 cfm). A flow limiter must be provided at the hydrogen supply.

Zero reference gas

Depending on the application, nitrogen (N₂), Quality 5.0, or synthetic air or catalytically cleaned air. Inlet pressure $p_e = 1000 \pm 100$ hPa (14.5 ± 1.45 psi), flow 130–250 l/h (0.076 to 0.15 cfm)

Span gas

Depending on the application, sample component or substitute gas component in N₂ or air. Inlet pressure $p_e = 1000 \pm 100$ hPa (14.5 ± 1.45 psi), flow 130–250 l/h (0.076 to 0.15 cfm)

Installation site

Ambient temperature

in operation:

Mounting plate	+5 to 35 °C (+41 to 95 °F)
Sheet steel version with fan	+5 to 35 °C (+41 to 95 °F)
with cooling unit	+5 to 50 °C (+41 to 122 °F)
Glass-fiber version with fan	-20 to 35 °C (-4 to 95 °F)
with fan and cooling unit	-20 to 50 °C (-4 to 122 °F)
for storage and transport:	+2 to 60 °C (+36 to 140 °F)
after drying parts	
in contact with condensate	-25 to 60 °C (-13 to 140 °F)

Relative humidity

$\leq 75\%$ annual average, for a short time up to 95 %, infrequent and slight condensation possible

Installation location requirements

The analyzer system must be installed at a vibration-free location and be protected from heavy dust contamination, direct thermal radiation and a corrosive atmosphere. See the dimensional drawings for minimum distance on the right and left. The sheet steel version and the mounting plate are only suitable for installation indoors; an air-conditioned room is recommended. The glass-fiber version is suitable for installation outdoors (not for version with CSA approval) and indoors; a weather protection roof must be provided. Installation location altitude max. 2000 m (6562 ft) above sea level

Safety, electromagnetic compatibility

The analyzer system complies with the provisions of the European directives 2014/35/EU (low voltage) and 2014/30/EU (electromagnetic compatibility).

Approvals

Approval for USA and Canada – CSA

The analyzer system in the 120/208 VAC version is certified for use in general purpose environment, evidenced by full compliance with standards CAN/CSA-C22.2 No. 61010-1-04 and No. 61010-2-010-04 and UL Std. No. 61010-1 (2nd edition).

Sheet steel cabinet: Exterior view

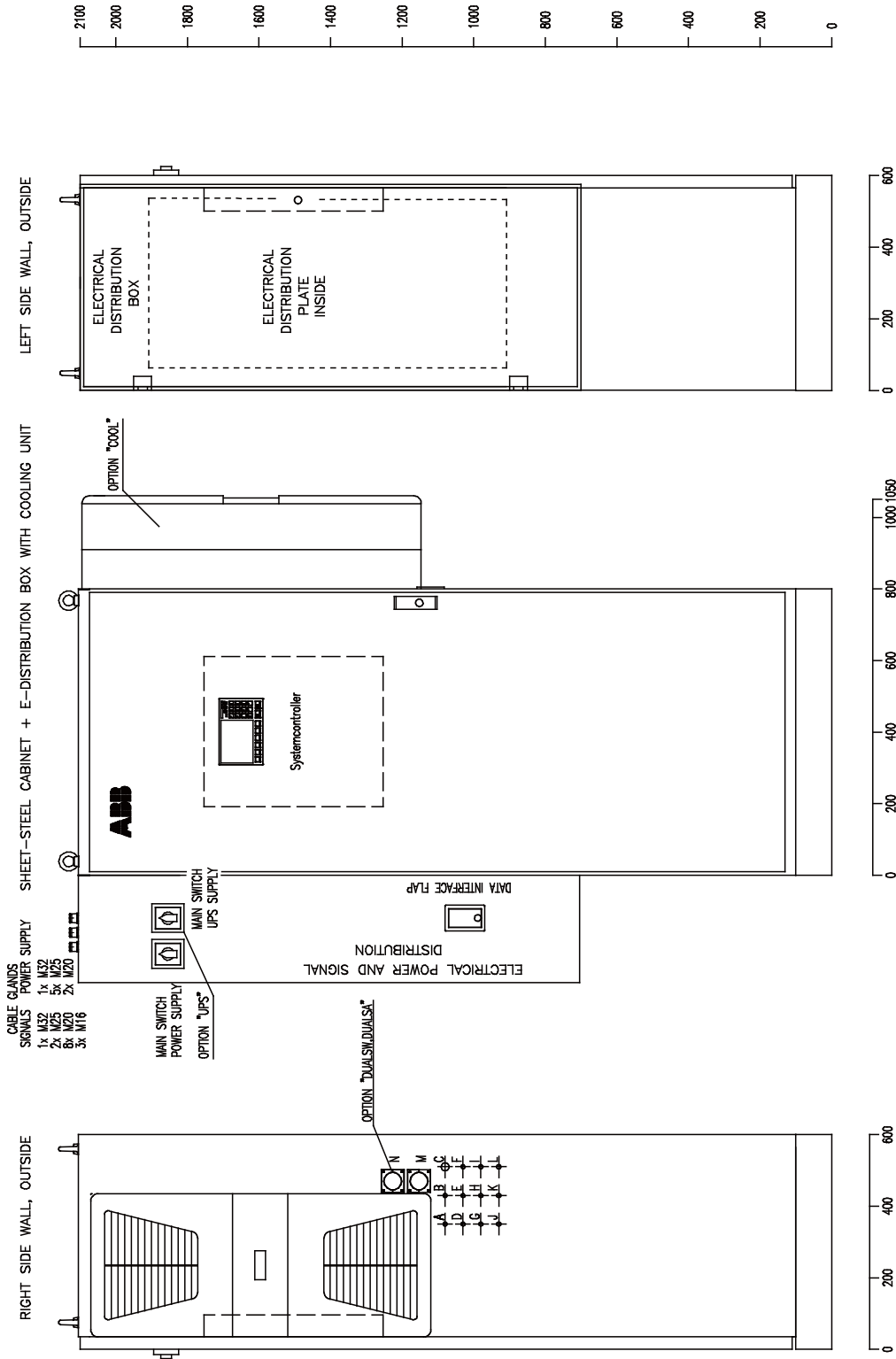

Sheet steel cabinet: Interior view

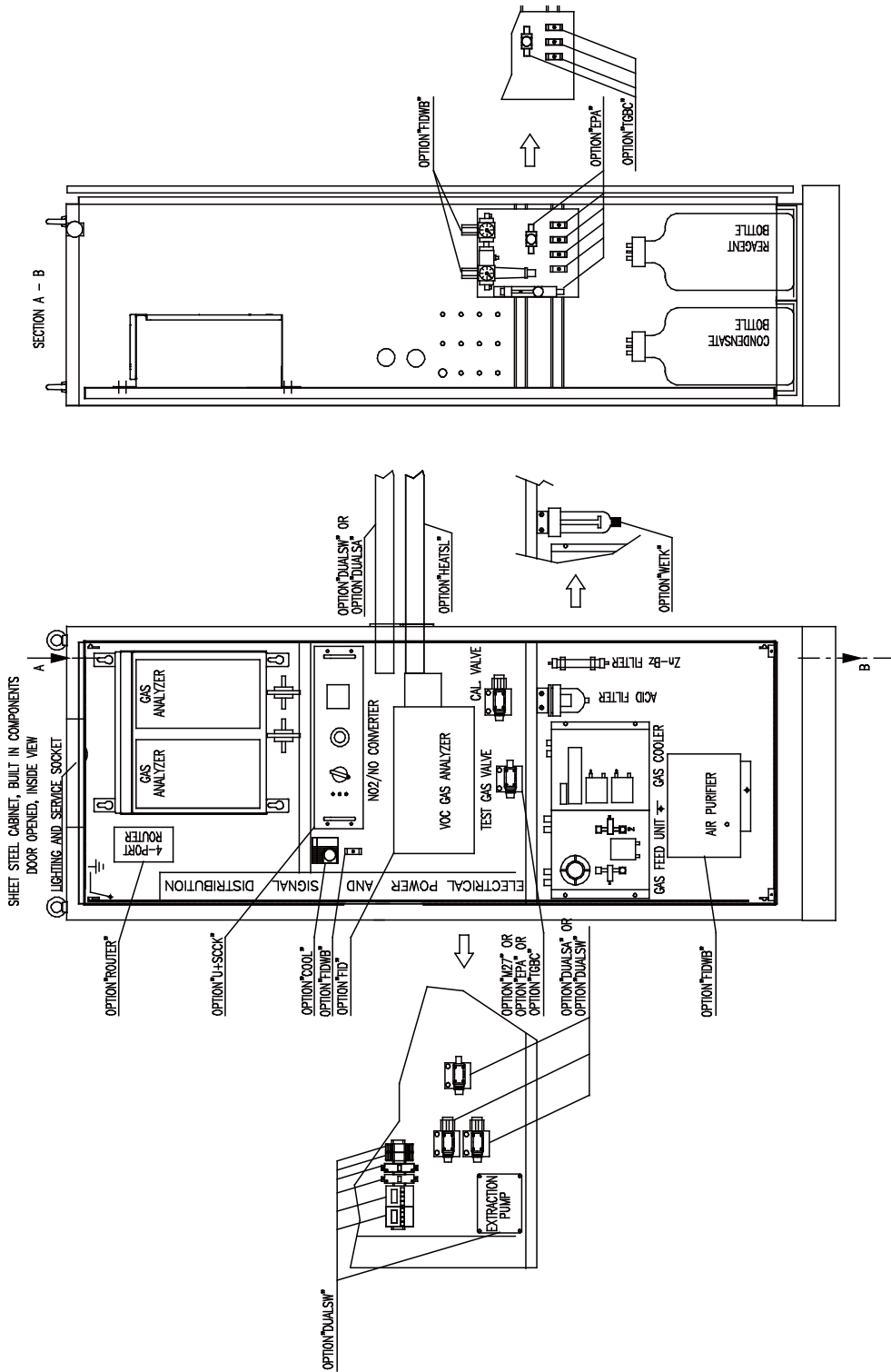

GRP cabinet: Exterior view

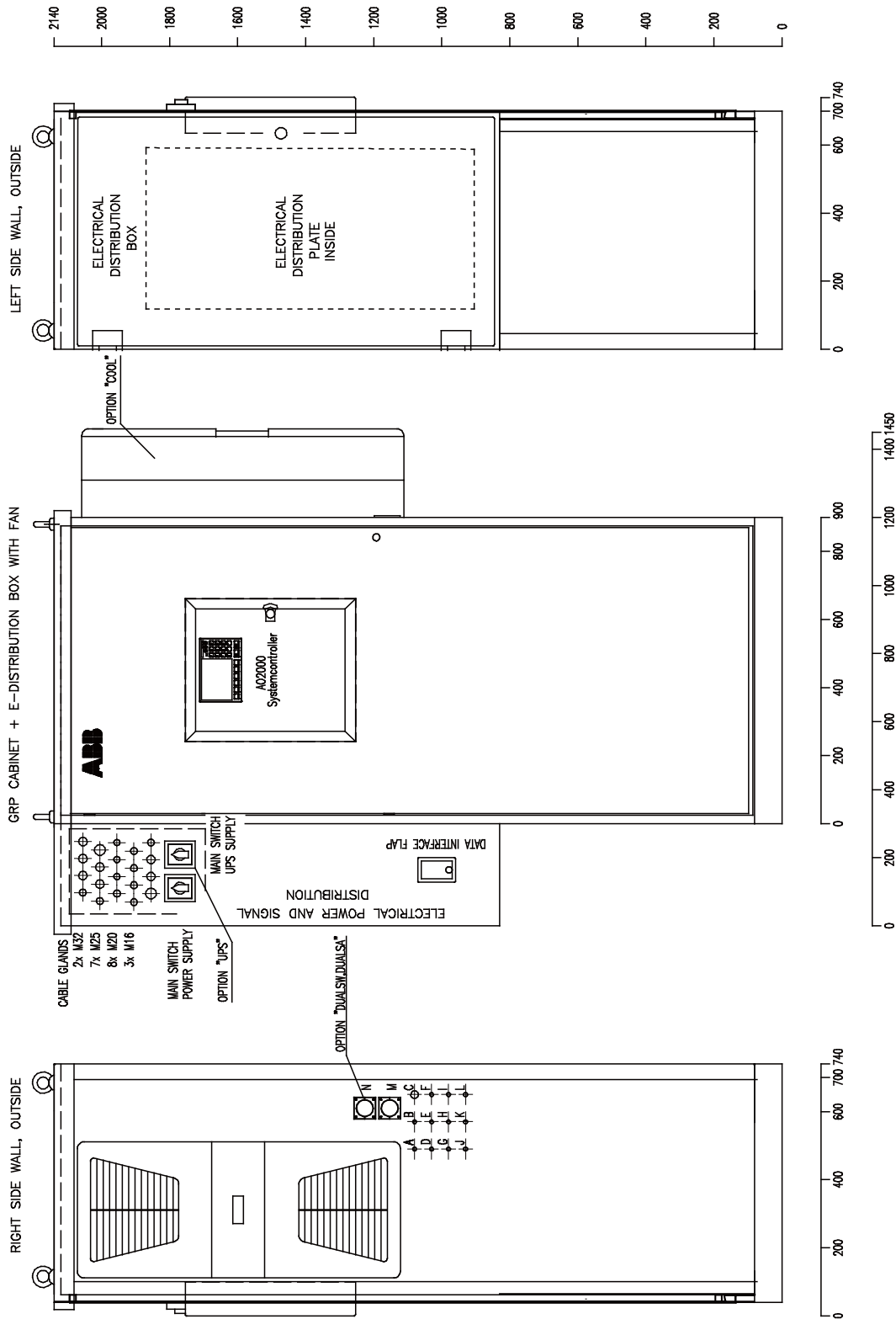

GRP cabinet: Interior view

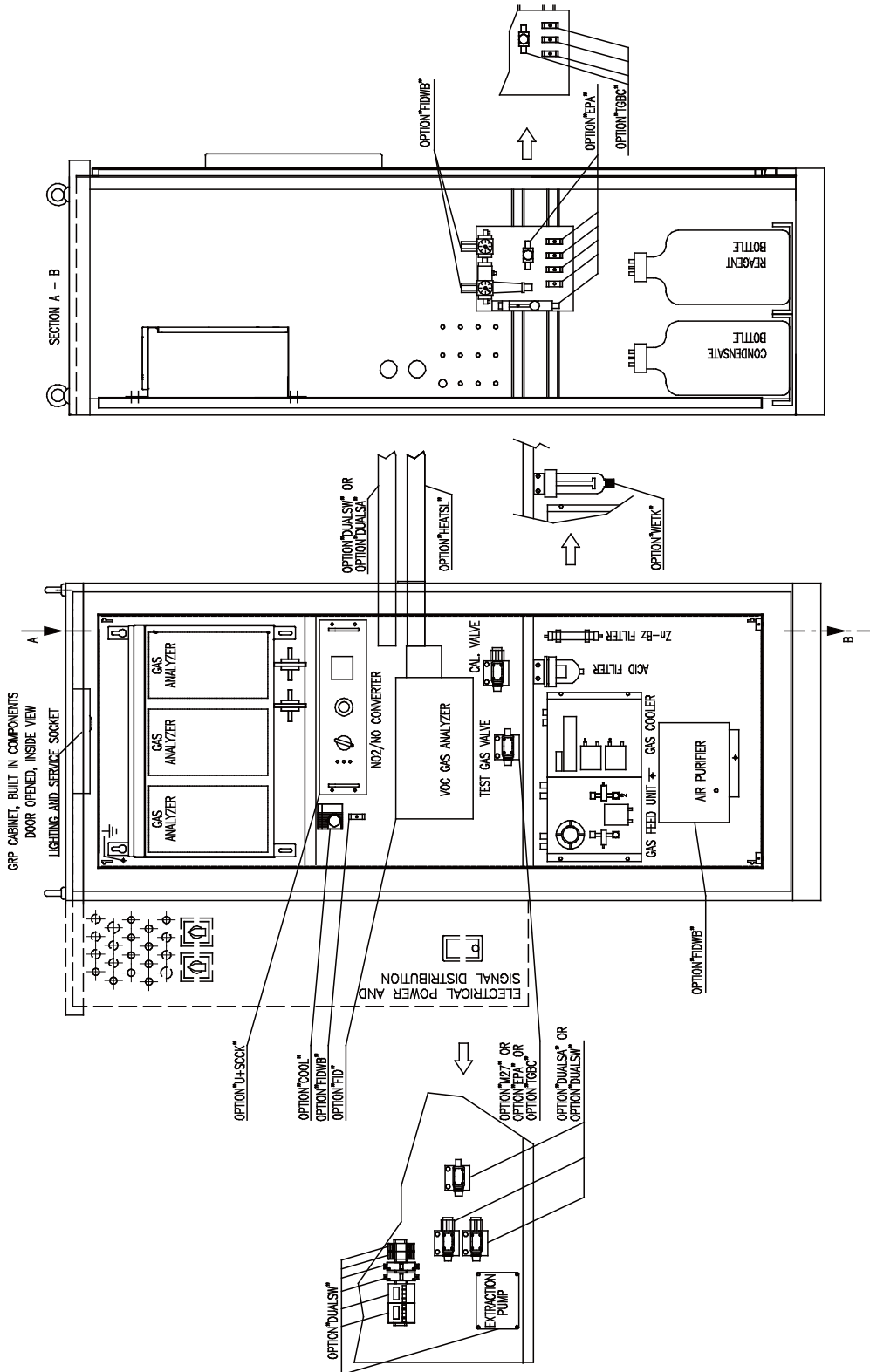

Mounting plate: View

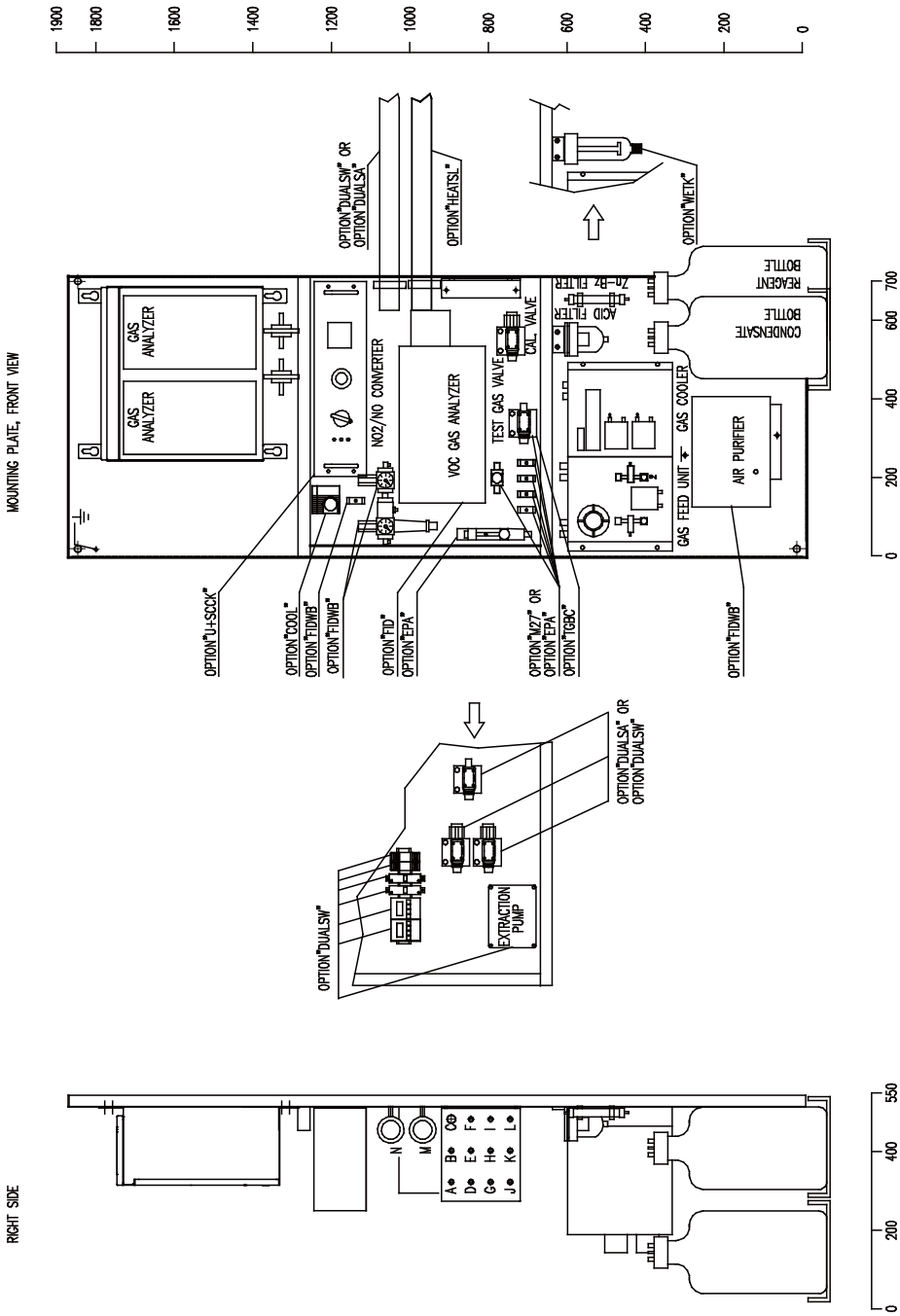

Electrical distribution cabinet: Exterior view

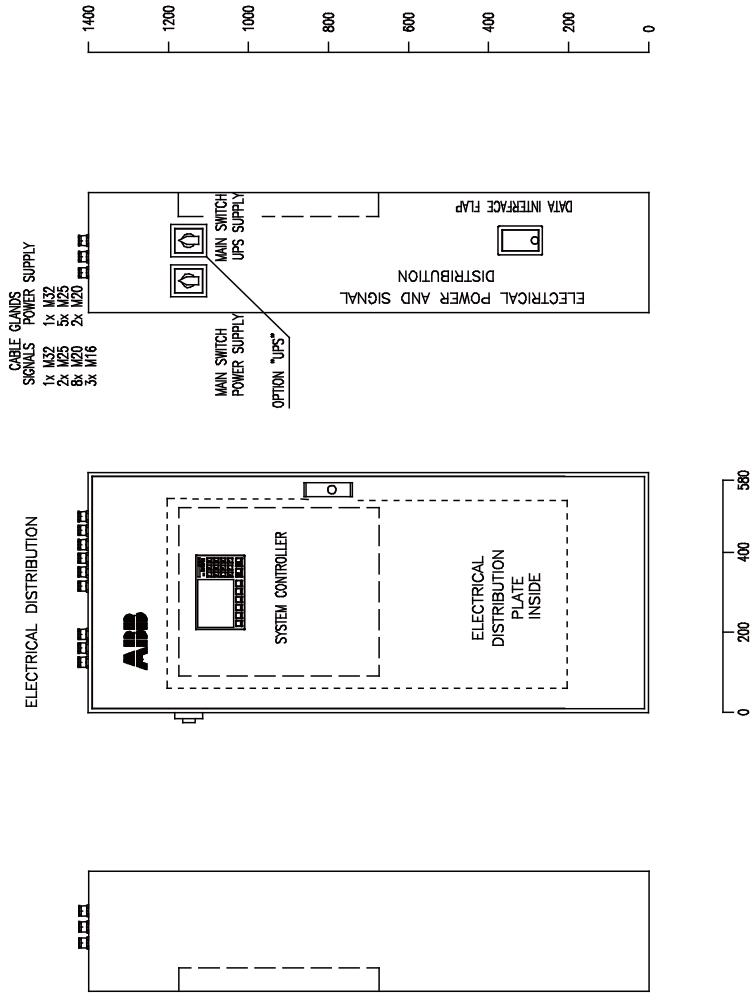

BACK PURGE UNIT FOR 2 SAMPLE POINTS

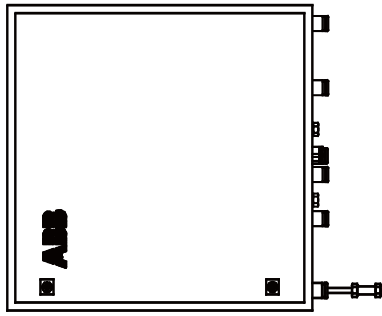

0 100 200 300 400 500 600 700 760

SHEET STEEL CABINET, RAL 7035, IP54

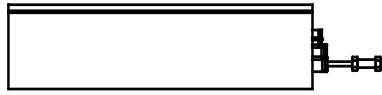

0 100 210

700
700
600
500
400
300
200
100
0

Back-purging unit: Exterior and interior view

DOOR OPENED:
2STAGE (FOR PFE3)

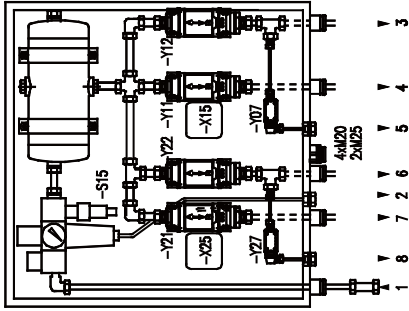

DOOR OPENED:
1STAGE (FOR PROBE2, PROBEF)

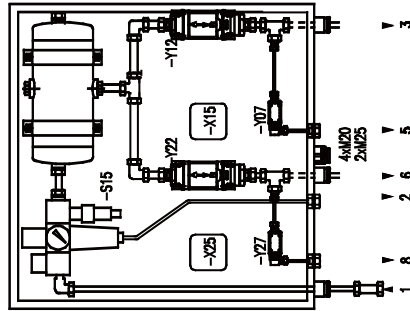

- | | | | |
|---|-------|--------------|-----------|
| 1 = COMPRESSED AIR INLET | Steel | OPTION "CSA" | DN 3/4" |
| 2 = CONDENSATE OUTLET | PVDF | "CSA"-Vers. | DN 1/4" |
| 3 = PURGING AIR OUTLET PROBE FILTER PROBE 1 | Steel | DN 18mm | DN 18mm*) |
| 4 = PURGING AIR OUTLET PROBE TUBE PROBE 1 | Steel | DN 6mm | DN 18mm*) |
| 5 = VENTILATE PROBE 1 | PVDF | DN 18mm*) | DN 1/4" |
| 6 = PURGING AIR OUTLET PROBE FILTER PROBE 2 | Steel | DN 18mm*) | DN 18mm*) |
| 7 = PURGING AIR OUTLET PROBE TUBE PROBE 2 | Steel | DN 18mm*) | DN 18mm*) |
| 8 = VENTILATE PROBE 2 | PVDF | DN 6mm | DN 1/4" |

-S15 = SETTING: 3,6bar LOWER SWITCHING POINT

*) USE DELIVERED STEEL COATED PTFE HOSES WITH 16mm SS CONNECTOR (LENGTH 6m)

ABB Measurement & Analytics

For your local ABB contact, visit:
www.abb.com/contacts

For more product information, visit:
www.abb.com/analytical

We reserve the right to make technical changes or modify the contents of this document without prior notice. With regard to purchase orders, the agreed particulars shall prevail.
ABB does not accept any responsibility whatsoever for potential errors or possible lack of information in this document.

We reserve all rights in this document and in the subject matter and illustrations contained therein. Any reproduction, disclosure to third parties or utilization of its contents – in whole or in parts – is forbidden without prior written consent of ABB.